

# Cable-Extension Position Transducer

**RS232 Data Communication**  
**Ranges: 0-2 to 0-50 inches**  
**Compact Size • OEM Applications**

# PT1232

## Specification Summary:

### GENERAL

Full Stroke Ranges ..... 0-2 to 0-50 inches  
 Electrical Interface ..... RS232  
 Format ..... Hex  
 Accuracy .....  $\pm 0.25$  to  $0.10\%$  full stroke  
 Repeatability .....  $\pm 0.02\%$  full stroke  
 Resolution .....  $\pm 0.003\%$  full stroke  
 Measuring Cable ..... 0.019-in. dia. nylon-coated stainless steel  
 Enclosure Material ..... glass-filled polycarbonate and anodized aluminum  
 Sensor ..... plastic-hybrid precision potentiometer  
 Potentiometer Cycle Life ..... *see ordering information*  
 Maximum Retraction Acceleration ..... *see ordering information*  
 Weight ..... 1 lb., max.

### ELECTRICAL

Input Voltage ..... 9...22 VDC  
 Input Current ..... 40 mA  
 Baud Rate ..... 9600 (selectable to 38.4K)  
 Update Rate ..... 32 msec

### ENVIRONMENTAL

Environmental Suitability ..... NEMA 4, IP 65  
 Operating Temperature .....  $0^{\circ}$  to  $185^{\circ}$ F ( $-17^{\circ}$  to  $85^{\circ}$ C)  
 Vibration ..... up to 10 G's to 2000 Hz maximum



The PT1232, part of our compact line of cable extension transducers, delivers position feedback via RS232 serial communication to your data acquisition or controller system. The PT1232 sends a raw 16-bit position count from 0000 to FFFF (hex). Additionally this device can be set to continuously send data or send data only when polled.

As the internal position sensing element is a precision potentiometer, this transducer maintains current accurate position even during power loss and does not need to be reset to a "home" position.

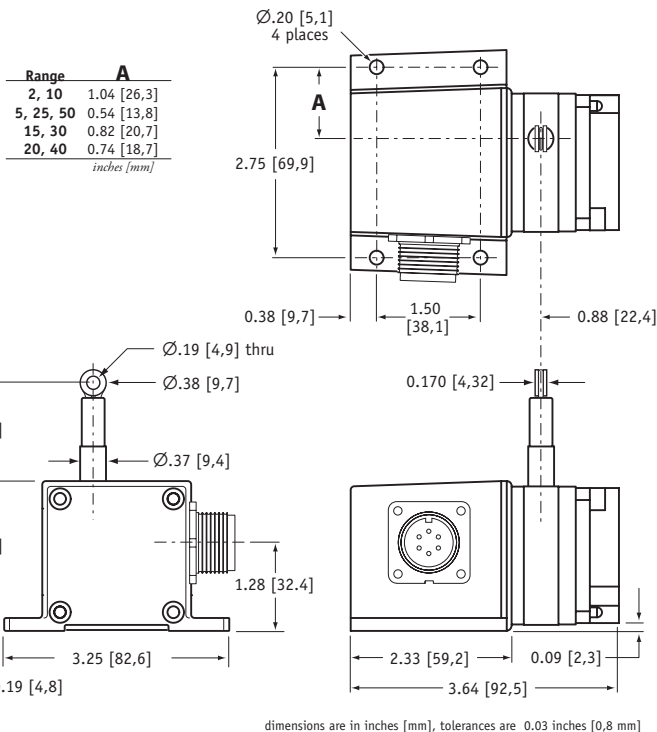

### Output Signal

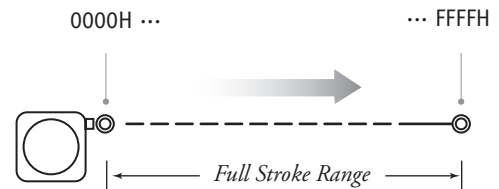

**I/O Format:**

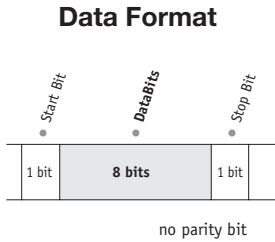

**Data Frame**

6 byte Hex string:

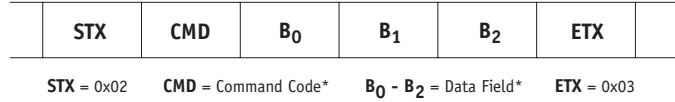

\*-see below

**Important!** All communications to/from the transducer are in **HEX!**

**User Commands:**

Description	User Command				Sensor Response			
	<CMD>	<B <sub>0</sub> >	<B <sub>1</sub> >	<B <sub>2</sub> >	<CMD>	<B <sub>0</sub> >	<B <sub>1</sub> >	<B <sub>2</sub> >
Get Sensor Info	0x05	0x00	0x00	0x00	0x05	version <sup>(4)</sup>	date <sup>(5)</sup>	date <sup>(5)</sup>
Get Serial Number	0x15	0x00	0x00	0x00	0x15	serial number <sup>(3)</sup>		
Start Continuous Data	0x25	0x00	0x00	0x00	0x25	0x00	0x00	0x00
Stop Continuous Data	0x35	0x00	0x00	0x00	0x35	0x00	0x00	0x00
Get Position Data	0x45	0x00	0x00	0x00	0x45	CMC <sup>(1)</sup>	CMC <sup>(1)</sup>	status <sup>(2)</sup>

**(1) CMC - Current Measurement Count (Position)**

The Current Measurement Count (CMC) is the output data that indicates the present position of the measuring cable.

The CMC is a 16-bit value that occupies the first two bytes (B<sub>0</sub> and B<sub>1</sub>) of the data field. B<sub>0</sub> is the MSB (most significant byte) and B<sub>1</sub> is the LSB (least significant byte).

The CMC starts at 0000H with the measuring cable fully retracted and continues upward to the end of the stroke range stopping at FFFFH. This holds true for all ranges.

**(2) Status**

The status byte is used as a flag to indicate the validity of the position signal that the internal electronics receives from the potentiometer.

Flags are as follows:  
0x00 = GREEN, 0x55 = YELLOW, 0xAA = RED

A "green" flag shows everything OK. A "yellow" or "red" flag indicates that the sensor has either been extended beyond its range or that there is a problem with the potentiometer.

**(3) Serial Number**

Each sensor has its own unique serial number. This information can be retrieved by sending the sensor the "Get Serial Number" command.

The serial number is a 3 byte value from which ranges from 0 to 9999999 (decimal).

**(4) Version**

This is a single byte value (0-255 decimal) which indicates the currently installed firmware version of the sensor.

**(5) Date**

This is a 2 byte value showing the date of currently installed firmware. This value ranges from 01011 - 12319 (decimal). Format is MMDDY. While the month and day are expressed as two digit numbers the year is expressed in a single digit only.

Example: 08054 = August 5, 2004

**Baud Rate**

The baud rate can be set using switches 7 & 8 on the 8-pole DIP switch found on the rs232 controller board located inside the transducer.

DIP-7	DIP-8	baud rate
0	0	9600
1	0	19200
0	1	38400
1	1	9600



**RS232 Controller Board and DIP Switch Location**

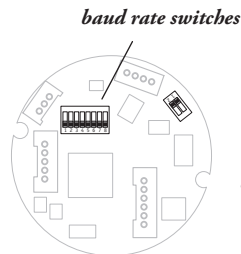

to gain access to the controller board, remove four Allen-Head Screws and remove rear cover.

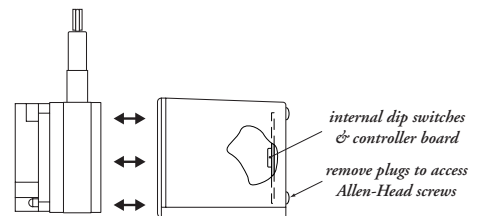

**Ordering Information:**

**Model Number:**

**PT1232** -      -      -      -       
*order code:*                    **R**            **A**            **B**            **C**

Sample Model Number:

**PT1232 - 50 - UP - M6 - SG**

- R** range: 50 inches
- A** measuring cable exit: up (top exit)
- B** electrical connection: 6-pin plastic connector
- C** cable guide: spring loaded

**Full Stroke Range:**

<b>R</b> <i>order code:</i>	<b>2</b>	<b>5</b>	<b>10</b>	<b>15</b>	<b>20</b>	<b>25</b>	<b>30</b>	<b>40</b>	<b>50</b>
full stroke range, min:	2 in.	5 in.	10 in.	15 in.	20 in.	25 in.	30 in.	40 in.	50 in.
accuracy (% of f.s.):	0.25%		0.15%			0.10%			
potentiometer cycle life:	2,500,000 cycles		500,000 cycles			250,000 cycles			
cable tension (20%):	12 oz.	5 oz.	12 oz.	9 oz.	6 oz.	5 oz.	9 oz.	6 oz.	5 oz.
maximum cable acceleration:	11 G's	3 G's	11 G's	5 G's	4 G's	3 G's	5 G's	4 G's	3 G's

**Cable Exit:**

**A** *order code:*                    **UP**                    **DN**                    **FR**                    **BK**  
 direction:                    up                    down                    front                    back

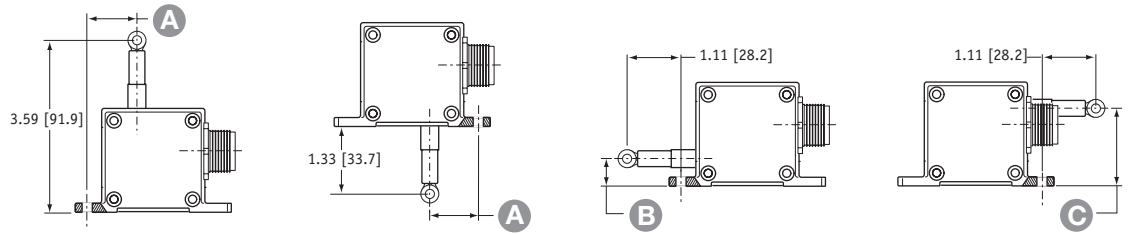

<i>measurement range</i>	<b>2</b>	<b>5</b>	<b>10</b>	<b>15</b>	<b>20</b>	<b>25</b>	<b>30</b>	<b>40</b>	<b>50</b>
<b>A</b>	1.04 in. 26,3 mm	0.54 in. 13,8 mm	1.04 in. 26,3 mm	0.82 in. 20,7 mm	0.74 in. 18,7 mm	0.54 in. 13,8 mm	0.82 in. 20,7 mm	0.74 in. 18,7 mm	0.54 in. 13,8 mm
<b>B</b>	0.75 in. 19,1 mm	0.29 in. 6,1 mm	0.75 in. 19,1 mm	0.53 in. 13,5 mm	0.45 in. 11,5 mm	0.29 in. 6,1 mm	0.53 in. 13,5 mm	0.45 in. 11,5 mm	0.29 in. 6,1 mm
<b>C</b>	1.43 in. 36,3 mm	1.89 in. 48,0 mm	1.43 in. 36,3 mm	1.65 in. 41,9 mm	1.73 in. 43,7 mm	1.89 in. 48,0 mm	1.65 in. 41,9 mm	1.73 in. 43,7 mm	1.89 in. 48,0 mm

**Electrical Connection:**

**B** *order code:*                    **M6**                    **C25**  
 6-pin plastic connector with mating plug                    25-ft. instrumentation cable 24 AWG, shielded

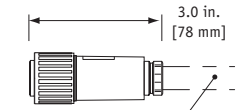

.30 - .39 in. [8 - 10 mm] cable dia.  
 16 AWG max conductor size  
 connector: MS3102E-14S-6P  
 mating plug: MS3106E-14S-6S

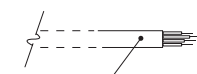

25 ft. x 0.2-in. dia.  
 [7,5 M x 5 mm dia.]  
 24 AWG, shielded

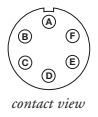

- pin**
  - A**
  - B**
  - C**
  - D**
  - E**
  - F**
- signal**
  - 9...22 VDC common
  - Transmitted Data
  - Received Data
  - common

- color code**
  - Red
  - Black
  - White
  - Green
  - Blue
  - Brown
- signal**
  - 9...22 VDC common
  - Transmitted Data
  - Received Data
  - common

**Cable Guide:**

Ⓞ *order code:*

**blank**

standard cable guide

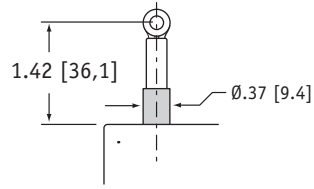

**SG**

spring-loaded guide

*cushions impact from accidental free release*

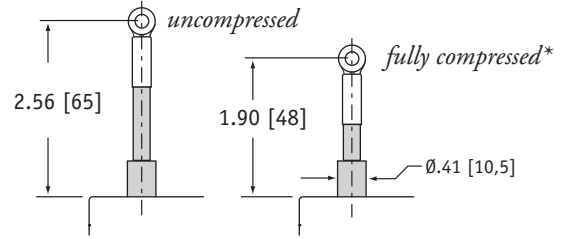

*\*note: start of full stroke range begins at **full compression** point*

version: 2.1 last updated: May 19, 2009